







Features



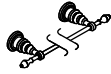

- Brass construction
- Traditional styling
- Complements IV Georges Brass faucet line

Colors/Finishes

- CP: Polished Chrome
- PB: Vibrant® Polished Brass
- Other: Refer to Price Book for additional colors/finishes

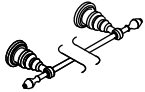
Specified Model

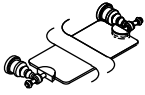
Model/Description	
18" (457 mm) towel bar <input type="checkbox"/> K-6816 <input type="checkbox"/> K-6816-A <input type="checkbox"/> K-6816-B <input type="checkbox"/> K-6816-C <input type="checkbox"/> PB <input type="checkbox"/> Other _____	
Towel ring <input type="checkbox"/> K-6817 <input type="checkbox"/> K-6817-A <input type="checkbox"/> K-6817-B <input type="checkbox"/> K-6817-C <input type="checkbox"/> PB <input type="checkbox"/> Other _____	
K-6818 Vertical toilet tissue holder <input type="checkbox"/> PB <input type="checkbox"/> Other _____	
K-6819-GD Tumbler and toothbrush holder, includes glass tumbler <input type="checkbox"/> PB <input type="checkbox"/> Other _____	
K-6820 Soap dish, includes removable clear acrylic dish <input type="checkbox"/> PB <input type="checkbox"/> Other _____	
K-6821 Robe hook <input type="checkbox"/> PB <input type="checkbox"/> Other _____	
K-6824 Mirror <input type="checkbox"/> Other _____	

Model/Description	
24" (610 mm) towel bar <input type="checkbox"/> K-6826 <input type="checkbox"/> K-6826-A <input type="checkbox"/> K-6826-B <input type="checkbox"/> K-6826-C <input type="checkbox"/> PB <input type="checkbox"/> Other _____	
K-6828 Horizontal toilet tissue holder <input type="checkbox"/> PB <input type="checkbox"/> Other _____	
K-6829 Glass Shelf <input type="checkbox"/> PB <input type="checkbox"/> Other _____	
K-6796 Accent kit for K-6818, K-6819, K-6820. K-6829 requires two kits. <input type="checkbox"/> PB <input type="checkbox"/> Other _____	
K-6798 Accent kit for K-6821 and K-6828 <input type="checkbox"/> PB <input type="checkbox"/> Other _____	

Product Specification

The accessories shall be of brass construction. Accessories shall have traditional styling. Accessories shall complement IV Georges Brass faucet line. Accessories shall be Kohler Model K-____-____.

IV GEORGES BRASS®

Installation Notes

Install this product according to the installation guide.

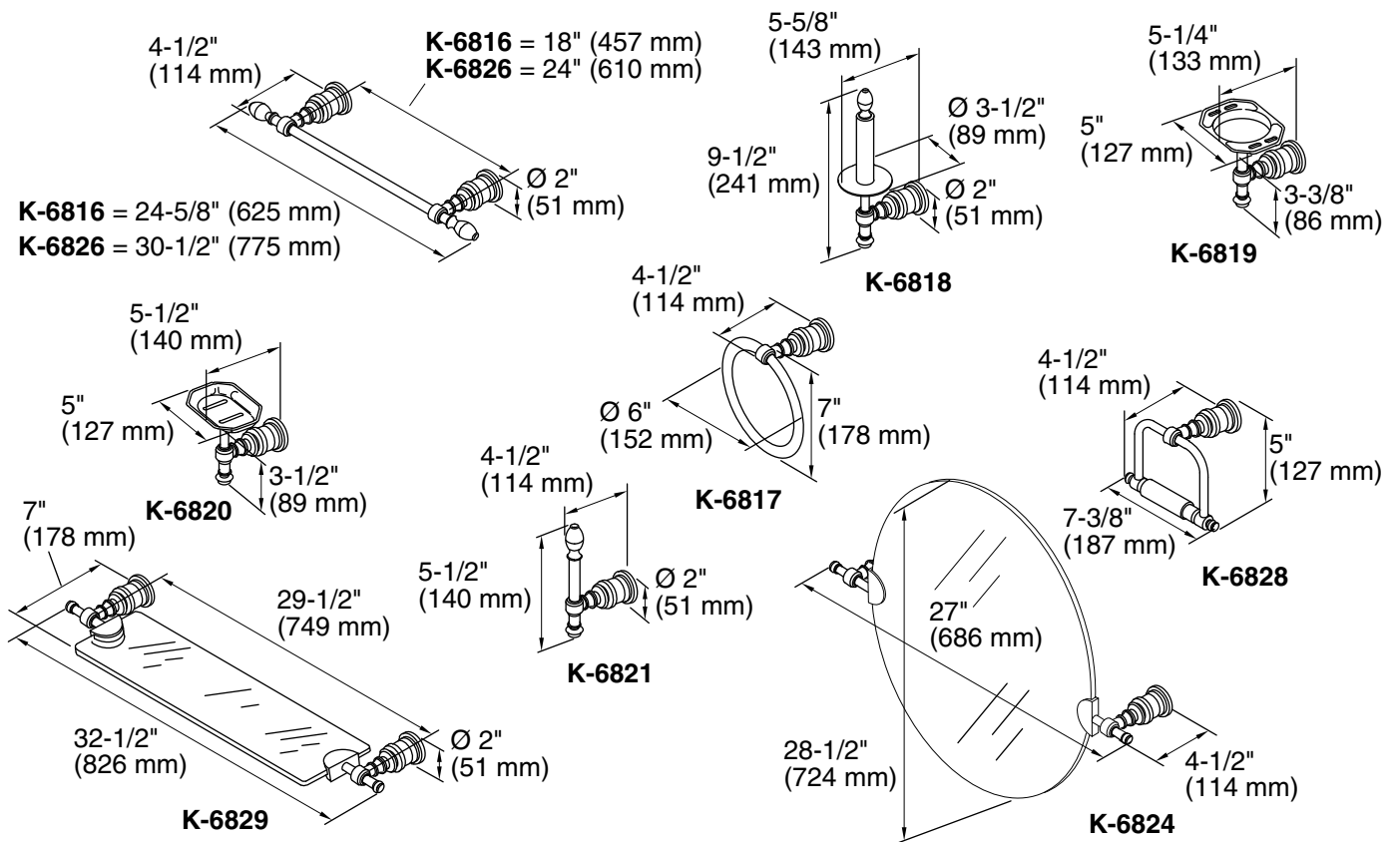

Product Diagram