

WADING POOL® BATHROOM SINK K-2332

ADA

Features

- Vitreous china
- Countertop installation
- 18-5/8" (473 mm) x 16-3/16" (411 mm)

Codes/Standards Applicable

Specified model meets or exceeds the following:

- ADA
- ASME A112.19.2/CSA B45.1
- ICC/ANSI A117.1

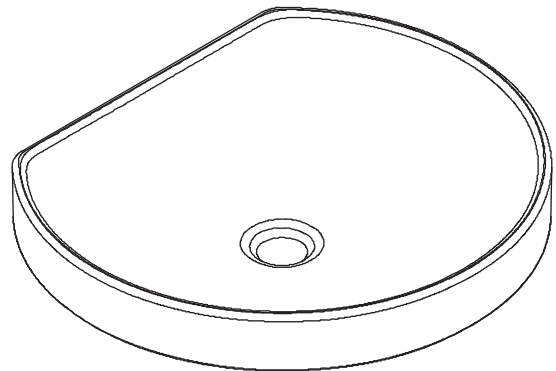

Colors/Finishes

- 0: White
- Other: Refer to Price Book for additional colors/finishes

Accessories:

- CP: Polished Chrome
- NA: None applicable
- Other: Refer to Price Book for additional colors/finishes

Specified Model

Model	Description	Colors/Finishes	
K-2332	Wading Pool bathroom sink	<input type="checkbox"/> 0	<input type="checkbox"/> Other_____
Required Accessories			
K-7710	Metal stopper OR	<input type="checkbox"/> CP	<input type="checkbox"/> Other_____
K-7715	Grid drain	<input type="checkbox"/> CP	<input type="checkbox"/> Other_____
Recommended Accessories			
K-9018	P-Trap	<input type="checkbox"/> CP	<input type="checkbox"/> Other_____
K-14407	Purist™ widespread faucet with high handles	<input type="checkbox"/> CP	<input type="checkbox"/> Other_____

Product Specification:

The vitreous china bathroom sink shall be 18-5/8" (473 mm) in length and 16-3/16" (411 mm) in width. Bathroom sink shall be for countertop installation. Product shall be Kohler Model K-2332-_____.

WATERCOVE®

Technical Information

Fixture*:	
Basin area	17-11/16" (449 mm) x 15-5/16" (389 mm)
Water depth	3-1/2" (89 mm)
Drain hole	Ø 1-3/4" (44 mm)
* Approximate measurements for comparison only.	
Included component:	
Cut-out template	1020955-7

Installation Notes

Install this product according to the installation guide.

Product does not have an overflow.

Choose a faucet that will provide adequate clearance and will direct the water stream to the center of the bathroom sink.

IMPORTANT! Product rests on a countertop. Consider height of product when planning the installation.

NOTICE: Countertop manufacturer or cutter must use the cut-out template provided with the product, or a current cut-out template provided by Kohler (call 1-800-4KOHLER). Kohler is not responsible for cutout errors when incorrect cut-out template is used.

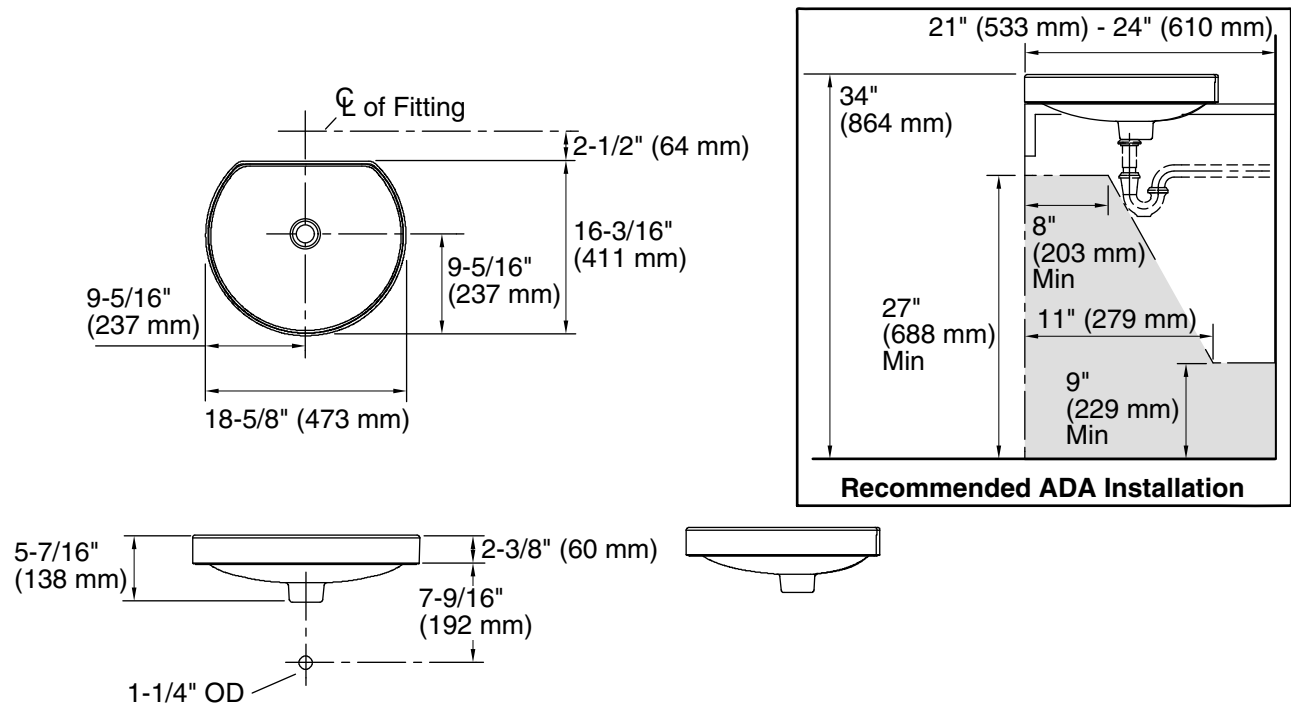

Product Diagram