

Features

- Acrylic
- Molded lumbar supports and armrests
- Integral apron/flange
- 60" (1524 mm) x 60" (1524 mm) x 21" (533 mm)

CORNER BATH WITH INTEGRAL APRON K-1161-LA

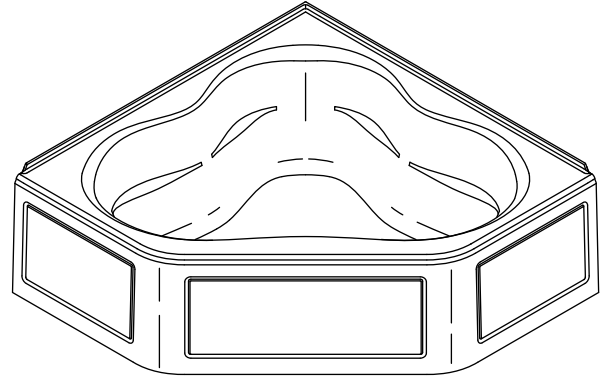

Codes/Standards Applicable

Specified model meets or exceeds the following:

- CSA B45.5/IAPMO Z124
- ASTM E162
- ASTM E662

Colors/Finishes

- 0: White
- Other: Refer to Price Book for additional colors/finishes

Accessories:

- CP: Polished Chrome

Specified Model

Model	Description	Colors/Finishes	
K-1161-LA	Integral apron/flange	<input type="checkbox"/> 0 White	<input type="checkbox"/> Other_____
Recommended Accessory			
K-11677	Drain	<input type="checkbox"/> CP	
Optional Accessory			
K-1491	Pillow	<input type="checkbox"/> 0 White	<input type="checkbox"/> Other_____

Product Specification:

The corner alcove bath shall be 60" (1524 mm) in length, 60" (1524 mm) in width, and 21" (533 mm) in height. Bath shall be made of acrylic. Bath shall have molded lumbar supports and armrests. Bath shall have optional K-1491 removable pillow. Bath shall be Kohler Model K-1161-LA-_____.

TERCET™

Technical Information

Fixture*:	basin area	top area	weight
Bathing well	52" (1321 mm) x 38-3/4" (984 mm)	61" (1549 mm) x 46-1/4" (1175 mm)	118 lbs. (53.6 kg)
	water depth	capacity	
To overflow	15" (381 mm)	96 gal. (363.6 L)	

* Approximate measurements for comparison only.

Installation Notes

Install this product according to the installation guide.

Floor support under bath must provide for a minimum of 35 lbs./square foot (172 kg/square meter) loading.

No change in measurements if connected with drain illustrated.

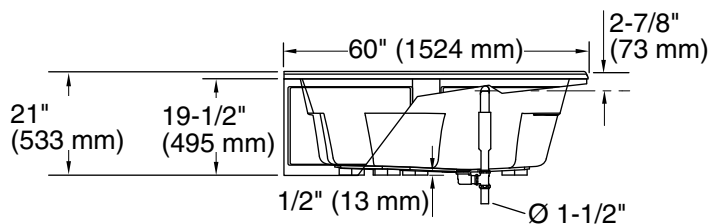
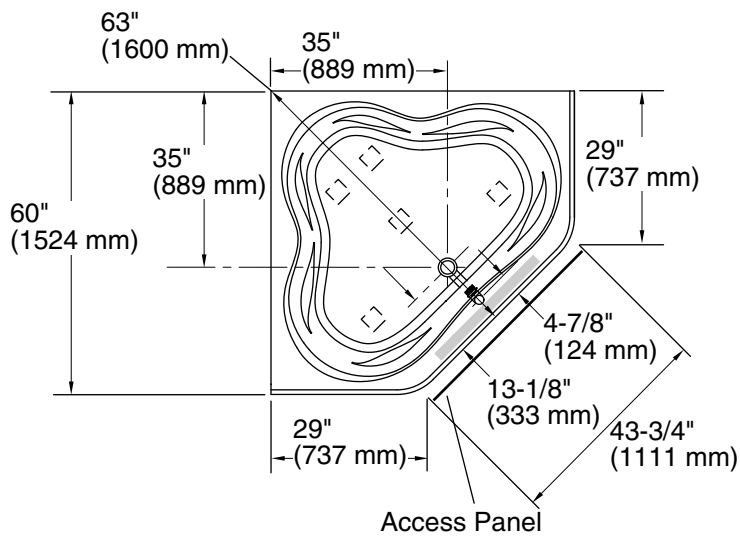

No change in measurements if connected with drain illustrated. (K-11677 or K-11677M)

Recommended faucet area

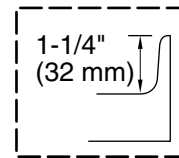

Tile Flange Detail

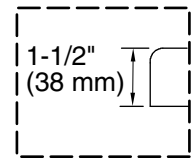

Drop-In Rim Detail

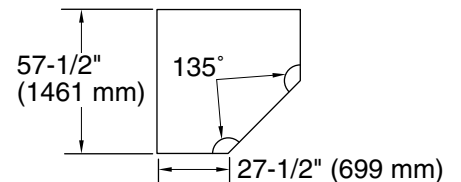

Drop-In Rim Style Cut-Out Detail

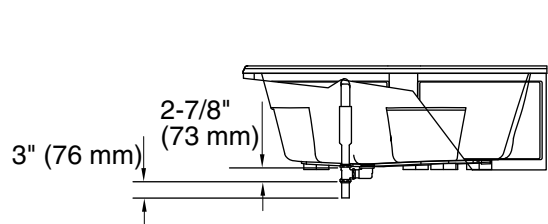

Product Diagram