

**BATHROOM SINK FAUCET
K-7305**

Features

- Brass construction
- Brass valve bodies
- Quarter-turn washerless ceramic disc valves
- 5-1/4" (133 mm) spout reach
- Available with standard or vandal-resistant Water-Guard® aerator
- Variety of handle style options
- 1.5 gallons (5.7 L) per minute flow rate [max at 60 psi (4.14 bar)]

ADA **CSA B651** **OBC**



Codes/Standards Applicable

Specified model meets or exceeds the following:

- ADA
- ICC/ANSI A117.1
- CSA B651
- OBC
- ASME A112.18.1/CSA B125.1
- EPA WaterSense®

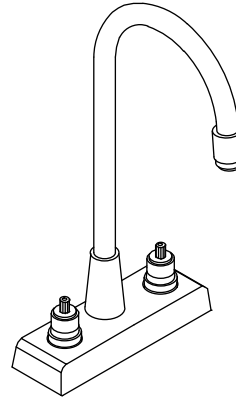

K-7305-K

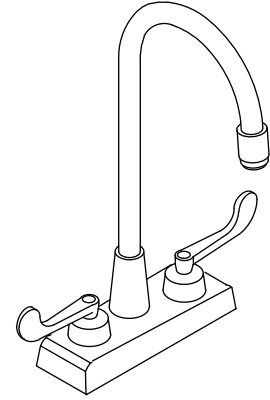





K-7305-5A

Colors/Finishes

- CP: Polished Chrome

Specified Model

Model	Description	Colors/Finishes
K-7305-K	Triton faucet with standard aerator – less handles and drain	<input type="checkbox"/> CP
K-7305-KE	Triton faucet with vandal-resistant Water-Guard® aerator – less handles and drain	<input type="checkbox"/> CP
K-7305-5A	Triton faucet with standard aerator and wristblade lever handles – less drain	<input type="checkbox"/> CP

Required Accessories (Includes Two Handles)			 ADA	 ADA	 ADA CSA B651 OBC
K-16010-2	Triton standard handles	<input type="checkbox"/> CP			
K-16010-3	Triton cross handles		<input type="checkbox"/> CP		
K-16010-4	Triton lever handles			<input type="checkbox"/> CP	
K-16010-5	Triton wristblade lever handles				<input type="checkbox"/> CP

Product Specification

Two-handle centerset bathroom sink faucet shall be made of brass construction with brass valve bodies. Faucet shall feature quarter-turn washerless ceramic disc valves, assuring positive handle stop positioning. Product shall be less drain and lift rod. Faucet shall feature a 1.5 gallons (5.7 L) per minute flow rate [max at 60 psi (4.14 bar)]. Product shall include 4" (102 mm) centers, 5-1/4" (133 mm) gooseneck spout, and standard or vandal-resistant Water-Guard® aerator. Base faucet shall be Kohler Model K-7305-_____-CP and handles shall be Kohler Model K-16010-_____-CP OR complete faucet shall be Kohler Model K-7305-5A-CP.

TRITON®

Optional Accessories		
1160595	Medium Spray 0.35 gpm (1.32 lpm) – Insert only	<input type="checkbox"/> NA
_____	Additional flow options are available (refer to the Price Book)	<input type="checkbox"/> NA

Installation Notes

Install this product according to the installation guide.

ADA, CSA B651, OBC compliant when installed to the specific requirements of these regulations.

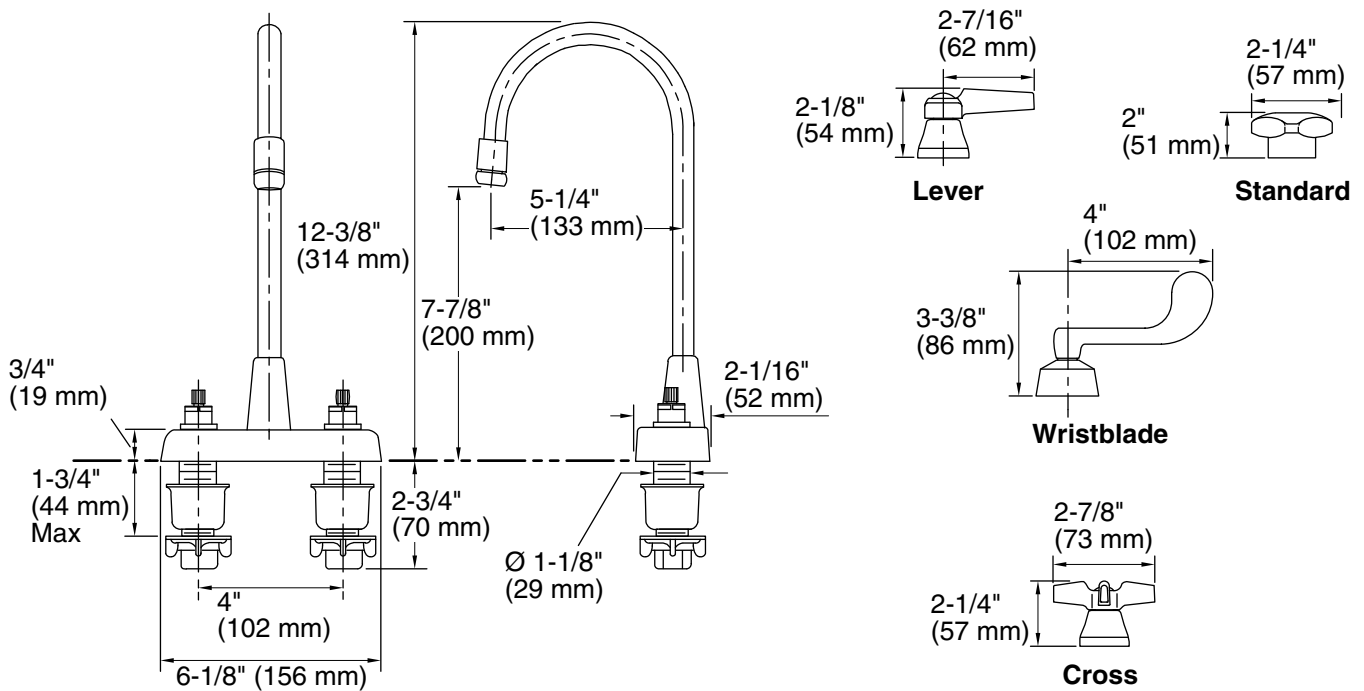

Product Diagram